



QA4 / QA6 / QA8 Series

Precision Air Nutrunners



Because every assembly is critical



There's much more to an assembly application than merely putting wrench to bolt. It's an intricate matter of linking tool users and fasteners to deliver an uncompromised combination of accuracy, durability, speed, and ergonomics.

The solution: Ingersoll Rand precision air nutrunners.

Our newly designed precision air nutrunners are compact, lightweight, quiet, and durable enough for the toughest high-volume applications, yet still deliver the speed and accuracy you need. The QA4, QA6, and QA8 Series tools are easy to maintain — which means less downtime — and are fully configurable in straight or angle configurations, shut-off or stall, with fixed or floating spindles, and in a variety of drive sizes up to 225 Nm.

Trusted tools, proven experience

At Ingersoll Rand, we have extensive experience with threaded fastening processes. For more than 100 years, we've worked with many of the world's leading manufacturers in various industries, and we understand the interface of the tool and operator. We know how to leverage the power of ergonomically designed equipment to maximize productivity and inspire progress.

Ingersoll Rand Fastening Portfolio

Ingersoll Rand offers a full line of production fastening equipment, including air and electric screwdrivers, nutrunners, drills, riveters, and pulse tools, as well as hand-held and multi-spindle fixtured DC nutrunners. Whether you need a solution for a single, specific application or an entire assembly line, you can trust our century of tool design experience to meet your needs.



A I R N U T R U N N E R S



Stall

- Excellent durability
- Economical alternative to shutoff tools
- Pressure-regulated max torque
- Angle and inline configurations
- Torque Range: 6 to 225 Nm
- Free speed: 90 to 1025 rpm

Recommended for non-critical applications or pressure controlled fixtured applications. Motor runs to stall providing consistent torque repeatability. Applied torque can be adjusted by regulating air pressure, but must be absorbed by the operator or reaction device.



Shutoff

- Excellent accuracy
- Excellent durability
- Excellent ergonomics for operator comfort
- Quick shutoff limits torque reaction
- Angle and inline configurations
- Torque range: 6 to 225 Nm
- Free speed: 90 to 1050 rpm

Recommended for applications where more precise torque control is required. Tool shuts off when preset torque is achieved, providing excellent repeatability with minimal torque reaction and reduced air consumption. The most accurate clutch available.



Remote

- Slim line for easy fixturing
- Excellent accuracy
- Excellent durability
- Shutoff or stall configurations
- Shutoff indicator port
- Torque range: 6 to 180 Nm
- Free speed: 125 to 1050 rpm
- Compatible with fixtured systems

For fixtured applications requiring air tools, Ingersoll Rand provides an entire line of remote start air tools. These reversible tools run without a lever on fixtured multiples or in a single workstation application.



Accessories

- Torque arms
- FRLs
- Hoses and fittings
- Sockets
- Balancers
- Gloves
- Calibration Equipment
- Service and more

Take advantage of our extensive line of accessories to optimize your assembly operations and maximize productivity.

Angle Nutrunners

Configurable to your application — don't see your configuration? Contact your Ingersoll Rand representative for custom options

Externally adjustable precision shutoff clutch for consistent joints; ISO 5393 tested

Ergonomic grip for operator comfort

Ideally positioned reverse ring for ease of use



360 degree indexing of anglehead provides maximum flexibility

Easy servicing with spanner wrench



Longer service life through precision machining and heat treatment

Non-lube motor



Quiet operation

Angle Shutoff Air Nutrunners

Model	in	@ 90 psi / 620 kPa		@ 77 psi / 530 kPa		lb (kg)	in (mm)	in (mm)	in (mm)	
		ft-lb (Nm)	rpm	ft-lb (Nm)	rpm					
QA4 Series Shut-off — 										
QA33SC10RL-25S6	3/8" □	3.7 – 8.5 (5 – 11)	1025	3.7 – 7.2 (5 – 9.7)	953	3.17 (1.44)	13.5" (342)	1.28" (33)	0.50" (13)	
QA33SB08RL-25S6	3/8" □	5.2 – 11.1 (7 – 15)	800	5.2 – 9.4 (7 – 12.7)	744	3.17 (1.44)	13.5" (342)	1.28" (33)	0.50" (13)	
QA33SB06RL-25S6	3/8" □	7.4 – 14.8 (10 – 20)	625	7.4 – 12.5 (10 – 17)	581	3.17 (1.44)	13.5" (342)	1.28" (33)	0.50" (13)	
QA33SB06RL-28S6	3/8" □	7.4 – 14.8 (10 – 20)	625	7.4 – 12.5 (10 – 17)	581	3.35 (1.52)	14.3" (363)	1.39" (35)	0.55" (14)	
QA33SC04RL-28S6	3/8" □	11.1 – 22.1 (15 – 30)	425	11.1 – 18.8 (15 – 25.5)	395	3.35 (1.52)	14.3" (363)	1.39" (35)	0.55" (14)	
QA33SC03RL-35S6	3/8" □	14.8 – 29.5 (20 – 40)	325	14.8 – 25.1 (20 – 34)	302	3.98 (1.81)	15.6" (395)	1.71" (44)	0.69" (18)	
QA33SC03RL-35S8	1/2" □	14.8 – 29.5 (20 – 40)	325	14.8 – 25.1 (20 – 34)	302	4.00 (1.81)	15.6" (395)	1.71" (44)	0.69" (18)	
QA33SB02RL-35S8	1/2" □	18.4 – 40.6 (25 – 55)	200	18.4 – 33.6 (25 – 45.5)	186	4.50 (2.04)	16.4" (418)	1.71" (44)	0.69" (18)	
QA6 Series Shut-off — 										
QA6AALS030NP35S06	3/8" □	11.1 – 22.1 (15 – 30)	580	11.1 – 19.9 (15 – 27)	550	5.05 (2.29)	16.9" (429)	1.71" (44)	0.69" (18)	
QA6AALS040NP35S06	3/8" □	14.8 – 29.5 (20 – 40)	430	14.8 – 25.8 (20 – 35)	405	5.05 (2.29)	16.9" (429)	1.71" (44)	0.69" (18)	
QA6AALS040NP35S08	1/2" □	14.8 – 29.5 (20 – 40)	430	14.8 – 25.8 (20 – 35)	405	5.07 (2.30)	16.9" (429)	1.71" (44)	0.69" (18)	
QA6AALS055NP35S08	1/2" □	18.4 – 40.6 (25 – 55)	320	18.4 – 36.1 (25 – 49)	300	5.07 (2.30)	16.9" (429)	1.71" (44)	0.69" (18)	
QA6AALS070NP43S08	1/2" □	25.8 – 51.6 (35 – 70)	225	25.8 – 45.7 (35 – 62)	215	5.07 (2.30)	16.6" (422)	1.76" (45)	0.85" (22)	
QA6AALS090NP43S08	1/2" □	33.2 – 66.4 (45 – 90)	185	33.2 – 59.0 (45 – 80)	175	5.07 (2.30)	16.6" (422)	1.76" (45)	0.85" (22)	
QA8 Series Shut-off — 										
QA8AALS040NP35S06	3/8" □	14.8 – 29.5 (20 – 40)	570	14.8 – 25.8 (20 – 35)	540	5.38 (2.44)	17.8" (453)	1.71" (44)	0.69" (18)	
QA8AALS040NP35S08	1/2" □	14.8 – 29.5 (20 – 40)	570	14.8 – 25.8 (20 – 35)	540	5.40 (2.45)	17.8" (453)	1.71" (44)	0.69" (18)	
QA8AALS055NP35S08	1/2" □	18.4 – 40.6 (25 – 55)	425	18.4 – 36.1 (25 – 49)	400	5.40 (2.45)	17.8" (453)	1.71" (44)	0.69" (18)	
QA8AALS070NP43S08	1/2" □	25.8 – 51.6 (35 – 70)	320	25.8 – 45.7 (35 – 62)	305	5.40 (2.45)	17.5" (445)	1.76" (45)	0.85" (22)	
QA8AALS090NP43S08	1/2" □	33.2 – 66.4 (45 – 90)	255	33.2 – 59.0 (45 – 80)	240	5.40 (2.45)	17.5" (445)	1.76" (45)	0.85" (22)	
QA8AALS115NP48S08	1/2" □	51.6 – 84.8 (70 – 115)	200	51.6 – 75.2 (70 – 102)	190	6.15 (2.79)	17.8" (452)	1.97" (50)	0.97" (25)	
QA8AALS150NP48S08	1/2" □	55.3 – 110.6 (75 – 150)	145	55.3 – 98.1 (75 – 133)	140	6.88 (3.12)	19.2" (489)	1.97" (50)	0.97" (25)	
QA8AALS200NF56S12	3/4" □	73.8 – 147.5 (100 – 200)	110	73.8 – 131.3 (100 – 178)	105	8.86 (4.02)	20.0" (508)	2.09" (53)	1.19" (30)	
QA8AALS225NF56S12	3/4" □	92.2 – 166.0 (125 – 225)	90	92.2 – 163.7 (125 – 222)	85	8.86 (4.02)	20.0" (508)	2.09" (53)	1.19" (30)	

Inline Nutrunners

Configurable to your application — don't see your configuration? Contact your Ingersoll Rand representative for custom options

Longer service life through precision machining and heat treatment

Precision shutoff clutch tested to 1 million cycles without failure

Ergonomic grip for operator comfort

Ideally positioned reverse ring for ease of use

Standard 4" inline spindle provides 19 mm of float to accommodate faster rundown in fixtured applications

Multiple mounting flange options provide flexibility to customize the application (see below)

Easy servicing with spanner wrench

Externally adjustable precision shutoff clutch for consistent joints; ISO 5393 tested

Powerful non-lube motor

Quiet operation

NON-LUBE

Inline Shutoff Air Nutrunners

Model	in	@ 90 psi / 620 kPa			@ 77 psi / 530 kPa			lb (kg)	in (mm)	in (mm)
		ft-lb (Nm)	rpm	1 min.	ft-lb (Nm)	rpm	1 min.			
QA4 Series Shut-off										
QA4ASLS012NP41S06	3/8" □	4.4 – 8.8 (6 – 12)	1050	4.4 – 7.4 (6 – 10)	977	3.22 (1.46)	18.3" (464)	0.81" (21)		
QA4ASLS015NP41S06	3/8" □	5.2 – 11.1 (7 – 15)	850	5.2 – 9.4 (7 – 12.7)	791	3.22 (1.46)	18.3" (464)	0.81" (21)		
QA4ASLS020NP41S06	3/8" □	7.4 – 14.8 (10 – 20)	600	7.4 – 12.5 (10 – 17)	558	3.22 (1.46)	18.3" (464)	0.81" (21)		
QA4ASLS027NP41S06	3/8" □	10.3 – 19.9 (14 – 27)	450	10.3 – 16.7 (14 – 22.7)	419	3.22 (1.46)	18.3" (464)	0.81" (21)		
QA4ASLS046NP41S06	3/8" □	14.8 – 33.9 (20 – 46)	250	14.8 – 28.0 (20 – 38)	233	3.73 (1.69)	18.8" (478)	0.91" (23)		
QA4ASLS046NP41S08	1/2" □	14.8 – 33.9 (20 – 46)	250	14.8 – 28.0 (20 – 38)	233	3.77 (1.71)	18.8" (478)	0.91" (23)		
QA6 Series Shut-off										
QA6ASLS025NP41S06	3/8" □	8.9 – 18.4 (12 – 25)	720	8.9 – 16.2 (12 – 22)	685	5.07 (2.30)	18.8" (478)	0.80" (20)		
QA6ASLS030NP41S06	3/8" □	11.1 – 22.1 (15 – 30)	605	11.1 – 19.2 (15 – 26)	575	5.07 (2.30)	18.8" (478)	0.80" (20)		
QA6ASLS040NP41S06	3/8" □	14.8 – 29.5 (20 – 40)	450	14.8 – 25.8 (20 – 35)	425	5.07 (2.30)	18.8" (478)	0.80" (20)		
QA6ASLS055NP41S08	1/2" □	18.4 – 40.6 (25 – 55)	325	18.4 – 36.1 (25 – 49)	310	5.09 (2.31)	18.8" (478)	0.80" (20)		
QA8 Series Shut-off										
QA8ASLS040NP41S06	3/8" □	14.8 – 29.5 (20 – 40)	600	14.8 – 25.8 (20 – 35)	570	5.27 (2.39)	19.7" (502)	0.80" (20)		
QA8ASLS040NP41S08	1/2" □	14.8 – 29.5 (20 – 40)	600	14.8 – 25.8 (20 – 35)	570	5.29 (2.40)	19.7" (502)	0.80" (20)		
QA8ASLS055NP41S08	1/2" □	18.4 – 40.6 (25 – 55)	470	18.4 – 36.1 (25 – 49)	445	5.29 (2.40)	19.7" (502)	0.80" (20)		
QA8ASLS070NP41S08	1/2" □	25.8 – 51.6 (35 – 70)	355	25.8 – 45.7 (35 – 62)	335	5.60 (2.54)	19.9" (506)	0.94" (24)		
QA8ASLS090NP41S08	1/2" □	33.2 – 66.4 (45 – 90)	255	33.2 – 59.0 (45 – 80)	245	6.33 (2.87)	21.3" (542)	0.94" (24)		
QA8ASLS115NF41S08	1/2" □	51.6 – 84.8 (70 – 115)	215	51.6 – 75.2 (70 – 102)	205	7.50 (3.40)	21.3" (541)	2.00" (51)		
QA8ASLS150NF41S08	1/2" □	55.3 – 110.6 (75 – 150)	165	55.3 – 98.1 (75 – 133)	160	7.50 (3.40)	21.3" (541)	2.00" (51)		
QA8ASLS180NF41S08	1/2" □	66.4 – 132.8 (90 – 180)	140	66.4 – 118.0 (90 – 160)	135	7.50 (3.40)	21.3" (541)	2.00" (51)		

Model	dBa	in	in (mm)	cfm
QA4	79.3	1/4" NPT	3/8" (10)	27
QA6	82.5	3/8" NPT	1/2" (13)	36
QA8	87	3/8" NPT	1/2" (13)	41

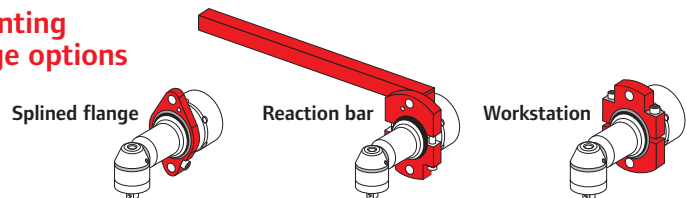

Mounting flange options



Remote Start



Remote Start Shut-off Air Nutrunners

Model	in	@ 90 psi / 620 kPa		@ 77 psi / 530 kPa		lb (kg)	in (mm)	in (mm)
		ft-lb (Nm)	rpm	ft-lb (Nm)	rpm			
QA4 Series Remote Start — 								
QA4ASRS012NF41S06	3/8" □	4.4 – 8.8 (6 – 12)	1050	4.4 – 7.4 (6 – 10)	977	3.55 (1.61)	17.8" (451)	0.81" (21)
QA4ASRS015NF41S06	3/8" □	5.2 – 11.1 (7 – 15)	850	5.2 – 9.4 (7 – 12.7)	791	3.55 (1.61)	17.8" (451)	0.81" (21)
QA4ASRS020NF41S06	3/8" □	7.4 – 14.8 (10 – 20)	600	7.4 – 12.5 (10 – 17)	558	3.55 (1.61)	17.8" (451)	0.81" (21)
QA4ASRS027NF41S06	3/8" □	10.3 – 19.9 (14 – 27)	450	10.3 – 16.7 (14 – 22.7)	419	3.55 (1.61)	17.8" (451)	0.81" (21)
QA4ASRS046NF41S06	3/8" □	14.8 – 33.9 (20 – 46)	250	14.8 – 28.0 (20 – 38)	233	4.06 (1.84)	18.3" (465)	0.91" (23)
QA4ASRS046NF41S08	1/2" □	14.8 – 33.9 (20 – 46)	250	14.8 – 28.0 (20 – 38)	233	4.06 (1.84)	18.3" (465)	0.91" (23)
QA6 Series Remote Start — 								
QA6ASRS025NF41S06	3/8" □	8.9 – 18.4 (12 – 25)	700	8.9 – 16.2 (12 – 22)	665	5.76 (2.61)	17.9" (454)	1.34" (34)
QA6ASRS030NF41S06	3/8" □	11.1 – 22.1 (15 – 30)	585	11.1 – 19.2 (15 – 26)	555	5.76 (2.61)	17.9" (454)	1.34" (34)
QA6ASRS040NF41S06	3/8" □	14.8 – 29.5 (20 – 40)	435	14.8 – 25.8 (20 – 35)	415	5.76 (2.61)	17.9" (454)	1.34" (34)
QA6ASRS055NF41S08	1/2" □	18.4 – 40.6 (25 – 55)	315	18.4 – 36.1 (25 – 49)	300	5.78 (2.62)	17.9" (454)	1.34" (34)
QA8 Series Remote Start — 								
QA8ASRS040NF41S06	3/8" □	14.8 – 29.5 (20 – 40)	540	14.8 – 25.8 (20 – 35)	515	6.03 (2.73)	18.8" (478)	1.34" (34)
QA8ASRS040NF41S08	1/2" □	14.8 – 29.5 (20 – 40)	540	14.8 – 25.8 (20 – 35)	515	6.05 (2.74)	18.8" (478)	1.34" (34)
QA8ASRS055NF41S08	1/2" □	18.4 – 40.6 (25 – 55)	425	18.4 – 36.1 (25 – 49)	405	6.05 (2.74)	18.8" (478)	1.34" (34)
QA8ASRS070NF41S08	1/2" □	25.8 – 51.6 (35 – 70)	320	25.8 – 45.7 (35 – 62)	305	6.80 (3.09)	19.0" (482)	1.69" (43)
QA8ASRS090NF41S08	1/2" □	33.2 – 66.4 (45 – 90)	230	33.2 – 59.0 (45 – 80)	220	7.53 (3.42)	20.4" (518)	1.69" (43)
QA8ASRS115NF41S08	1/2" □	51.6 – 84.8 (70 – 115)	195	51.6 – 75.2 (70 – 102)	185	8.02 (3.64)	20.4" (517)	2.00" (51)
QA8ASRS150NF41S08	1/2" □	55.3 – 110.6 (75 – 150)	150	55.3 – 98.1 (75 – 133)	145	8.02 (3.64)	20.4" (517)	2.00" (51)
QA8ASRS180NF41S08	1/2" □	66.4 – 132.8 (90 – 180)	125	66.4 – 118.0 (90 – 160)	120	8.02 (3.64)	20.4" (517)	2.00" (51)

Putting it all together

Ingersoll Rand precision air nutrunners, fastening accessories, and services set the standard for excellence — assuring you the accuracy, flexibility, and durability you need to maximize your productivity.



Productivity

Ingersoll Rand delivers a complete solution to get the job done right.

- ▶ **Assembly line audits** — to optimize your fastening processes
- ▶ **Highest-quality tools and accessories** — to improve your product quality, line ergonomics and process flow
- ▶ **Torque arms and tubes, overhead rail, and hangers** — to enhance the layout, ergonomics, and ultimately the speed of your line
- ▶ **Calibration and service contracts** — to ensure your line is running to its full potential day in and day out

Accuracy

Ingersoll Rand delivers the accuracy you need to ensure the quality of your product.

- ▶ **Quick, precise clutch shutoff** limits scatter and torque reaction to the operator
- ▶ **Adjustable shutoff clutch** provides repeatability that improves joint quality
- ▶ **ISO 5393 tested**
- ▶ **Cycle counting capability** enables integration into process flow systems

Flexibility

With Ingersoll Rand you get the flexibility to choose the system that fits your application.

- ▶ **Three powerful motor options** to match the speed to need
- ▶ **Choice of inline or angle configurations**
- ▶ **Adjustable shutoff clutch or stall**
- ▶ **Multiple spindle lengths, floats, and drive sizes**
- ▶ **360-degree anglehead indexing**
- ▶ **Single or multi-spindle fixtured systems** to increase productivity and improve joint quality

Durability

Ingersoll Rand stands behind every tool and accessory, and offers the service levels you should expect from a leader in the industry.

- ▶ **2-year warranty** on anglehead and clutch
- ▶ **Clutch tested to over 1 million cycles** without failure
- ▶ **Proven components** from our world-class QE Series DC tools
- ▶ **Long life** reduces your life-cycle costs

QTA Torque Arms



Ingersoll Rand offers an impressive line of ergonomic torque reaction arms that help operators work more safely and comfortably while maximizing efficiency, to ensure product quality and minimize downtime. See the full QTA Torque Arm brochure (IRPS-0907-044) for a complete listing of torque arm products and specifications.

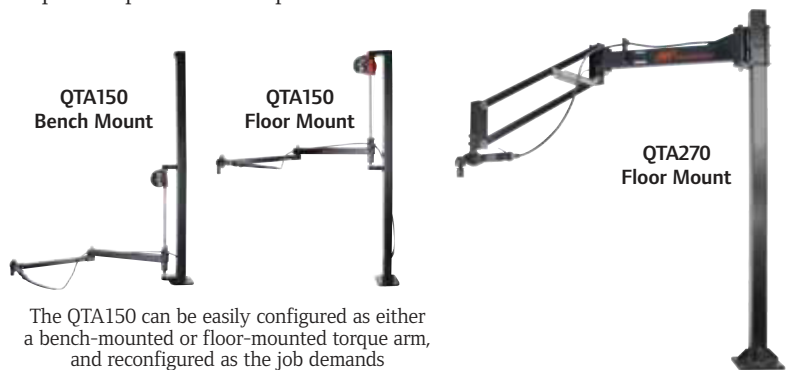

Model	Max Torque Nm (ft-lb)	Max Weight Capacity lb (kg)	Max. Working Reach in (mm)	Approx. Vertical Travel in (mm)	Overall Height in (mm)
QTA010	10 (7.4)	2.64 (1.20)	15 (381)	13.0 (330)	27.8 (706)
QTA020	20 (14.8)	5.00 (2.27)	20 (508)	14.5 (368)	31.8 (808)
QTA040	40 (29.5)	6.50 (2.95)	25 (635)	17.5 (445)	39.7 (1008)
QTA100	100 (73.8)	8.00 (3.63)	30 (762)	17.5 (445)	39.7 (1008)
QTA150	150 (110.6)	10.00 (4.54)	52 (1321)	22.0 (559)	78.7 (2000)
QTA270	270 (199)	22.00 (10.00)	60 (1524)	18.8 (477)	78.7 (2000)
QTA475	475 (350)	50.60 (23.00)	79 (2007)	23.2 (590)	78.7 (2000)

Accessories

Tool Accessory Kits

Mounting Flanges			Reaction Bar	Workstation	Full Spine
QA4 Inline	QA6 / QA8 Inline	QA6 / QA8 Angle			
up to 27 Nm	up to 55 Nm	up to 90 Nm	GEA15-K48	GEA4-K48	15E4-K48
46 Nm	70 / 90 Nm	115 / 150 Nm	DEA120-K48	DAM120-K48	GEM120-K48
Mounting Flanges (QA4 tools only)					Smooth Clamp
QA4 models (angle and inline)					QA4-K48
Swivel Hangers					
QA4 models					129851
QA6 and QA8 models					QA6-A365-S
Lever Kits (QA4 tools only)					
Extended lever					131654
Locking lever					131655
Exhaust Kits					
QA4 models					QA4-EXH-989
QA6 and QA8 models					QA6-K284
QA4 Cycle Count Port Kit					
For lever tool only (built-in on remote)					131711
Angle Head Boots (listed by head diameter)					
25 mm	28 mm	35 mm	43 mm	48 mm	56 mm
131996	131995	131997	GEA40-172	GEA40-173	GEA240-173
Spanner Wrench*					
For use with all models					GEA40-478



Expert Torque Wrench



FRL



Calibration equipment



Boots

Literature

Catalog Name	Form Number	Catalog Name	Form Number
DC Tools	AS-0206-061	Torque Arms	IRPS-0907-044
Pulse Tools	SW041107	Accessories	IR-0605-097
Audit Wrench	ASM-1106-128	Fixture Systems	IRITS-1107-043
Assembly	IRPS-1007-052	Impact Screwdriver	IRITS-1107-044
Feed Drill	52475-AT-C	Impact Sockets	IRPS-0506-016

Additional Accessories

Filter, Regulator, Lubricator, and Lubricant		
FRL Combo Unit	1/4" NPT	C28221-800
Lubricant Class 1 #10	pint	10P
Lubricant Class 1 #10	gallon	10G
Qualifiers and Light Hoses (QA4 tools only)		
QC Qualifier		QC200-S-K
Light hose	16' with 1/4" NPT fitting	QXLH-16-14
Calibration Equipment		
ETT Torque Tester	3 – 30 Nm torque range	ETT-30-US
ETA Torque Analyzer		ETA5
Rotary Transducer	3/8" sq dr, 3.8 – 75 Nm, standard	TR75S6
	3/8" sq dr, 3.8 – 75 Nm, Smart	TRD75S6
	1/2" sq dr, 9 – 180 Nm, standard	TR180S8
	1/2" sq dr, 9 – 180 Nm, Smart	TRD180S8
	3/4" sq dr, 12.5 – 250 Nm, standard	TR250S12
Stationary Transducer	3/8" sq dr, 7.5 – 150 Nm, standard	TS150S6
	1/2" sq dr, 15 – 300 Nm, standard	TS300S8
	3/4" sq dr, 50 – 1000 Nm, standard	TS1000S12
Expert Torque Wrench		ETW-E75
		ETW-E180

* See our comprehensive Maintenance Manuals for a complete listing of tool repair fixtures and photo detailed assembly and disassembly procedures.

Tune-up Kits

Tool Series	Motor Kit	Housing Kit	Clutch Ball Kit
QA4	QA4-1-K53	QA4-1-K40	QA4-1-K581
QA6	QA6-1-K53	QA6-1-K40	QA6-1-K581
QA8	QA8-1-K53	QA8-1-K40	QA6-1-K581
QA6 / QA8 Remote		QA6-1R-K40	

Manuals

Tool Series	Product	Parts	Maintenance
QA4	80160336	80160344	80217474
QA6	16601064	16601072	16601056
QA8	16601064	16601072	16601056

To find manuals on the Web: www.irtechpubs.com

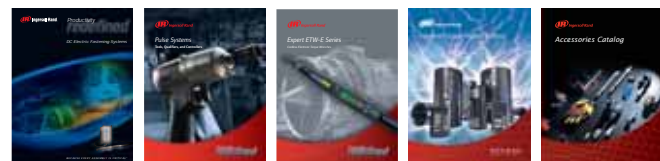

DC Tools Pulse Tools Audit Wrench Impact Sockets Accessories

The best equipment deserves the best service

At Ingersoll Rand, we know how important your equipment is to your livelihood. That's why for the past 100 years we've been setting the standard for not just powerful and durable products, but also for providing total solutions that help you get the job done right.

As tough as our equipment is, we also know that it needs to be maintained. When the time comes, let Ingersoll Rand meet your service and repair needs through our expansive Certified Service Network.

Each Certified Service provider has the specialized testing equipment, genuine parts, and skilled training to ensure you're back up and running at Original Equipment Manufacturer (OEM) specifications.

Global reach, local service

No matter where your facility is located, Ingersoll Rand is committed to serving you 24 hours a day, seven days a week. Our worldwide network of distributors, certified, factory-trained technicians, and engineers are a phone call away — ready to support you with innovative and cost-effective solutions that will keep you running at peak performance.



**Repairs done right.
Service made simple.**

irtools.com/tools/fastening



Distributed by:



Ingersoll Rand Industrial Technologies provides products, services and solutions that enhance our customers' energy efficiency, productivity and operations. Our diverse and innovative products range from complete compressed air systems, tools and pumps to material and fluid handling systems and environmentally friendly microturbines. We also enhance productivity through solutions created by Club Car®, the global leader in golf and utility vehicles for businesses and individuals.

(800) 376-TOOL • irtools.com